

SPECIFICATIONS FOR LED DISPLAYS

6.2mm(0.25") Seven Segments Quadruple Digit

LFD025 -10 Series

WENRUN OPTOELECTRONIC

Features:

- High efficiency, low power consumption.
- Extremely low current.
- Luminous evenly distributed on each segment.
- Low development cost.

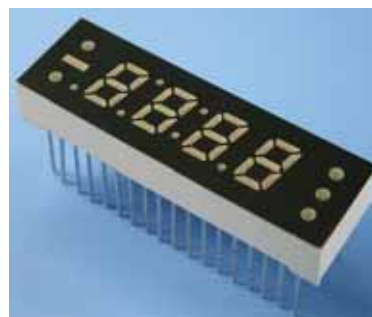
**LFD025A/B/C/D/E/F/G/H -10****Descriptions:**

- Industrial standard size.
- These display provide excellent reliability in bright ambient light.
- These devices are made with white segments and black surface.

Applications:

- Audio equipment or instrument panels.
- General use for digital indicators.
- Multimedia product.

Selection guide:

Part No.		Chip		Lens Color
Anode	Cathode	Material	Emitting Color	
LFD025B/D/F/HSR-10	LFD025A/C/E/GSR-10	GaAlAs	Super Red	White Diffused
LFD025B/D/F/HG-10	LFD025A/C/E/GG-10	GaP	Green	

Absolute Maximum Rating (Ta=25)

Parameter	Symbol	Super Red	Green	Unit
Power Dissipation/Segment	P_d	50	60	mW
Peak Forward Current /Segment (Duty 1/10@ 1KHz)	I_{FP}	70	70	mA
Continuous Forward Current /Segment	I_F	20	20	mA
Recommend use current /Segment	I_F	5~10	5~10	mA
Reverse Voltage /Segment	V_R	5	5	V
Operating Temperature Range	T_{opr}	-25~ +75		
Storage Temperature Range	T_{stg}	-30 ~ +85		
Solder Temperature	T_{sol}	260 ± 5		

- Notes :** 1、 This is the limit current . It is not allowed to use when the product work continuously.
 2、 It is recommended that the product is driven by TTL,CMOS.
 3、 Soldering time 5 seconds.

Electrical Optical Characteristics (Ta=25)

Parameter	Symbol	Super Red		Green		Unit	Test Condition
		Typ.	Max.	Typ.	Max.		
Luminous Intensity /Segment	I_V	3.4	--	1.7	--	mcd	$I_F=10mA$
Forward Voltage /Segment	V_F	1.85	2.3	2.2	2.5	V	$I_F=20mA$
Reverse Current /Segment	I_R	--	50	--	50	uA	$V_R=5V$
Dominant Wavelength	λ	645	--	565	--	nm	$I_F=20mA$
Spectral Line Half Width		30	--	30	--	nm	$I_F=20mA$

Package Dimensions:

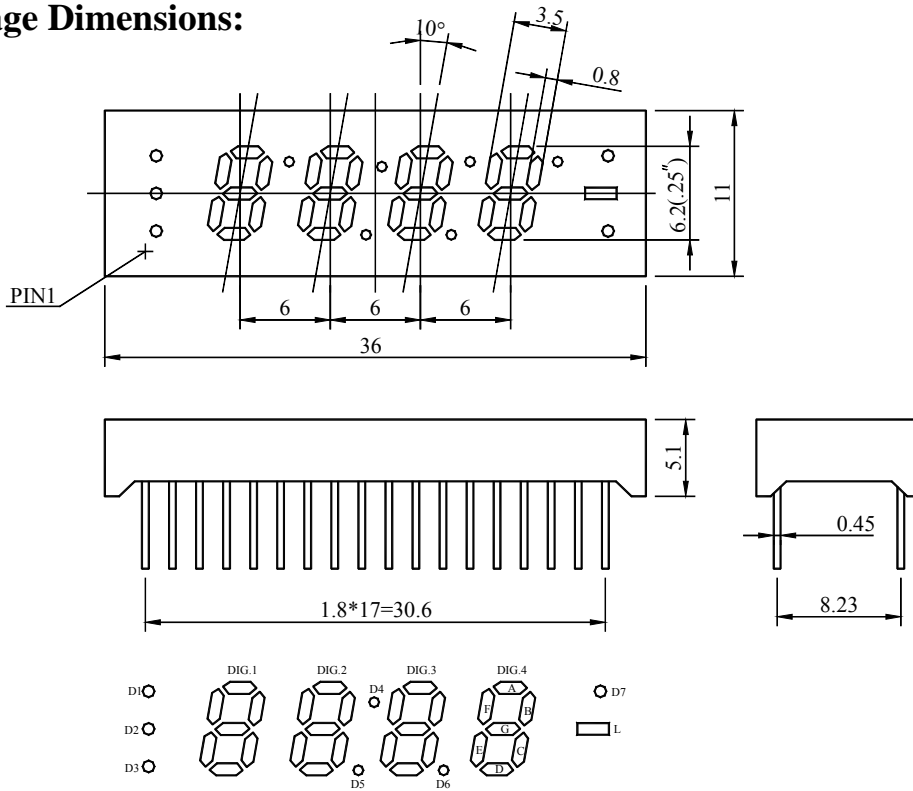

NOTES :

- All dimensions are in millimetres (mm), Tolerance is $\pm 0.25\text{mm}$ unless otherwise noted
- Specifications are subject to change without notice.

Internal Circuit:

Common Cathode

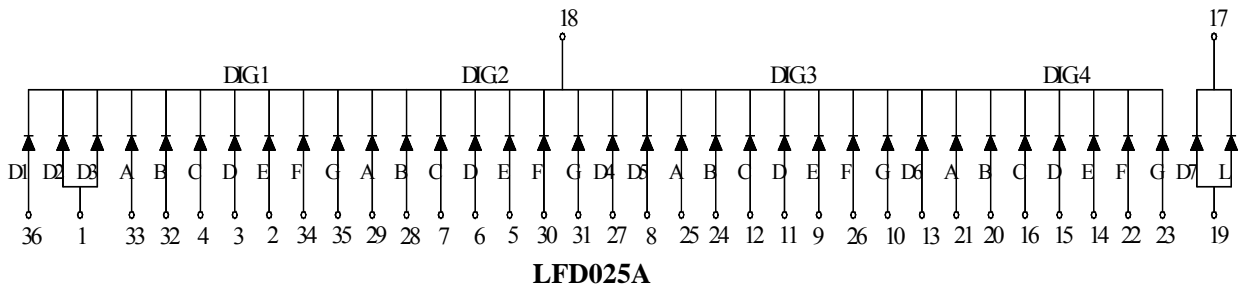

Common Anode

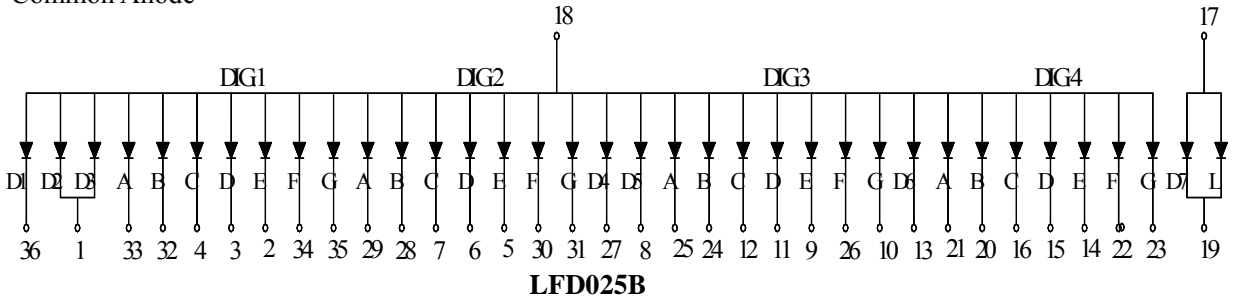

Package Dimensions:

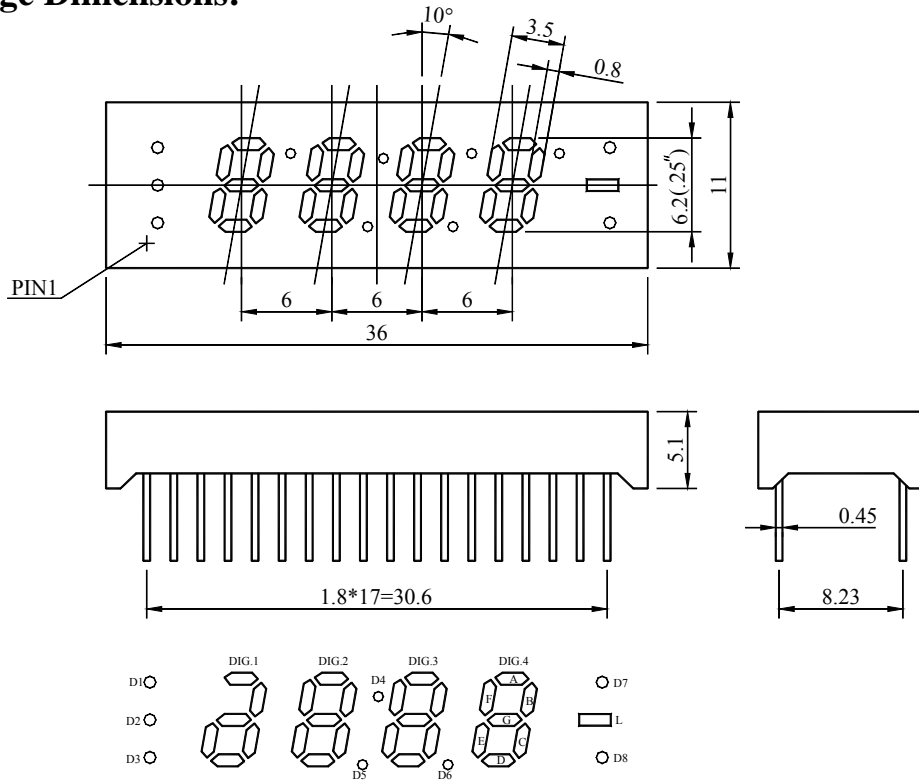

NOTES :

- All dimensions are in millimetres (mm), Tolerance is $\pm 0.25\text{mm}$ unless otherwise noted.
- Specifications are subject to change without notice.

Internal Circuit:

Common Cathode

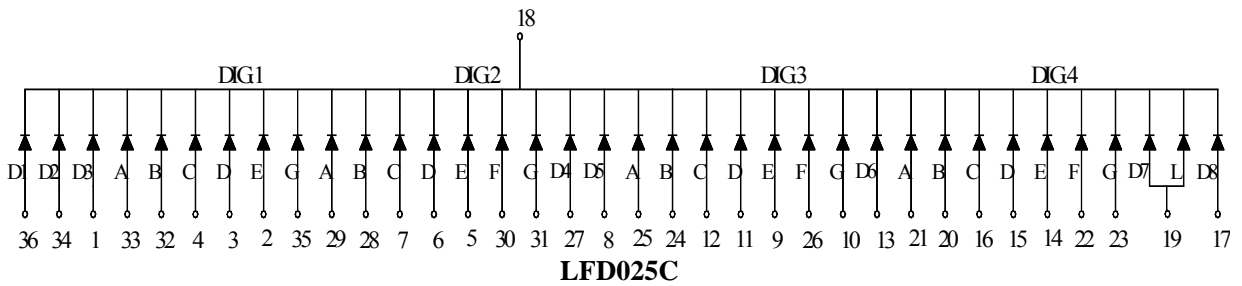

Common Anode

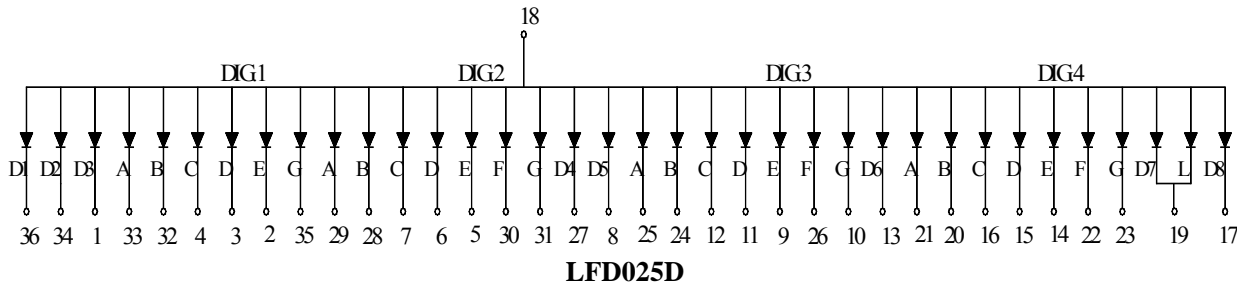

Package Dimensions:

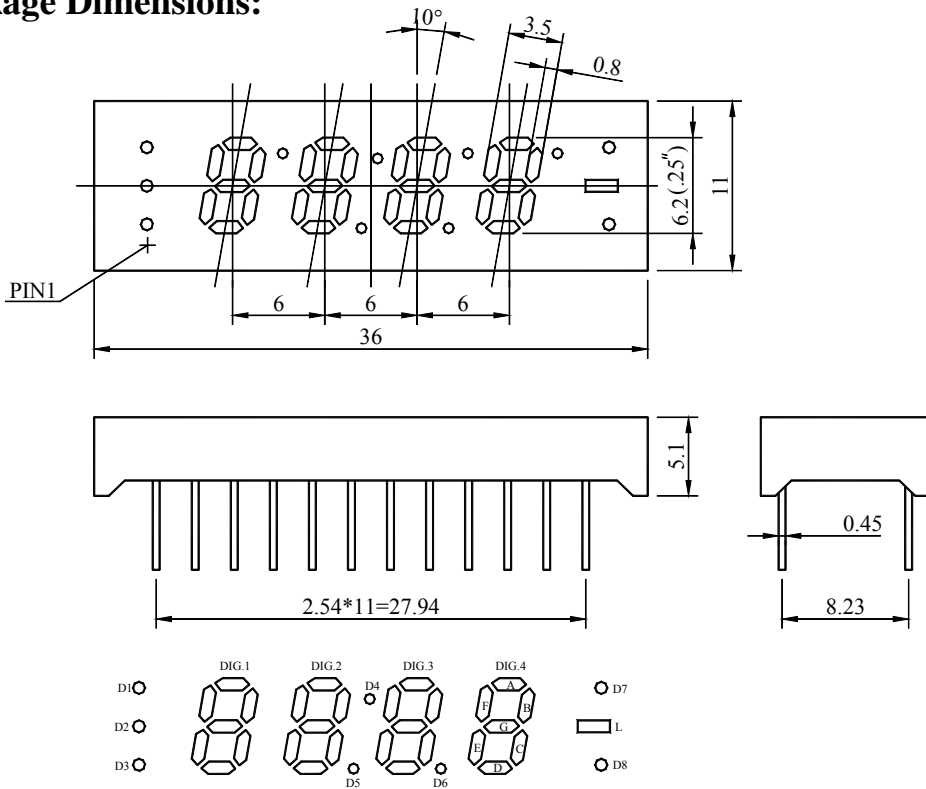

NOTES :

- All dimensions are in millimetres (mm), Tolerance is $\pm 0.25\text{mm}$ unless otherwise noted.
- Specifications are subject to change without notice.

Internal Circuit:

Common Cathode

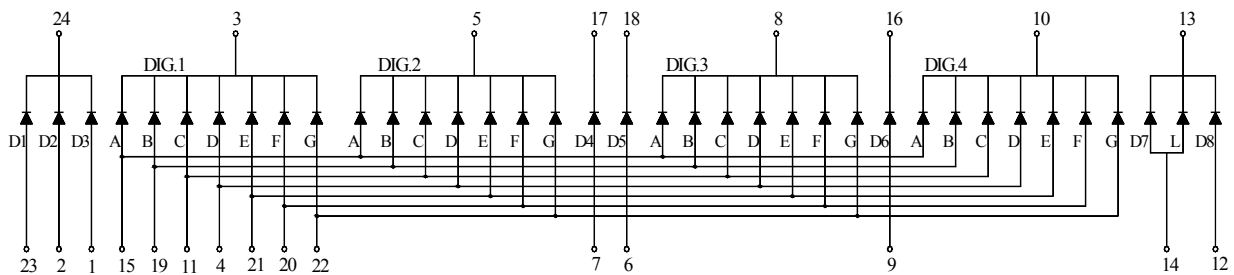

Common Anode

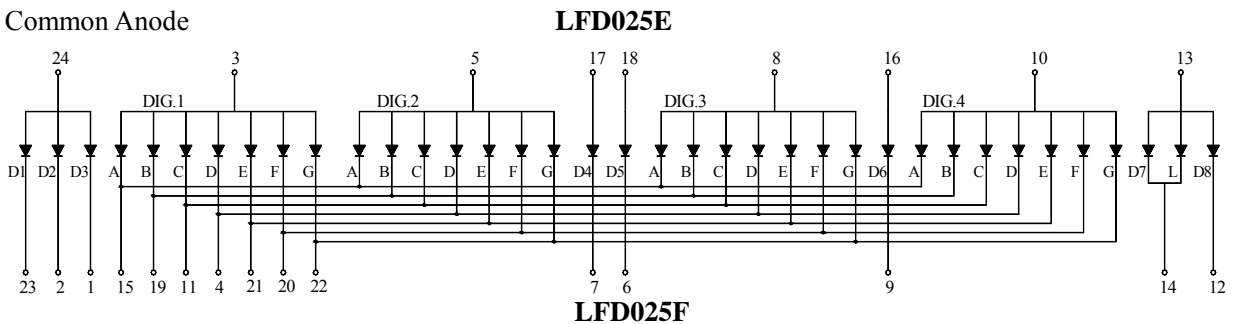

Package Dimensions:

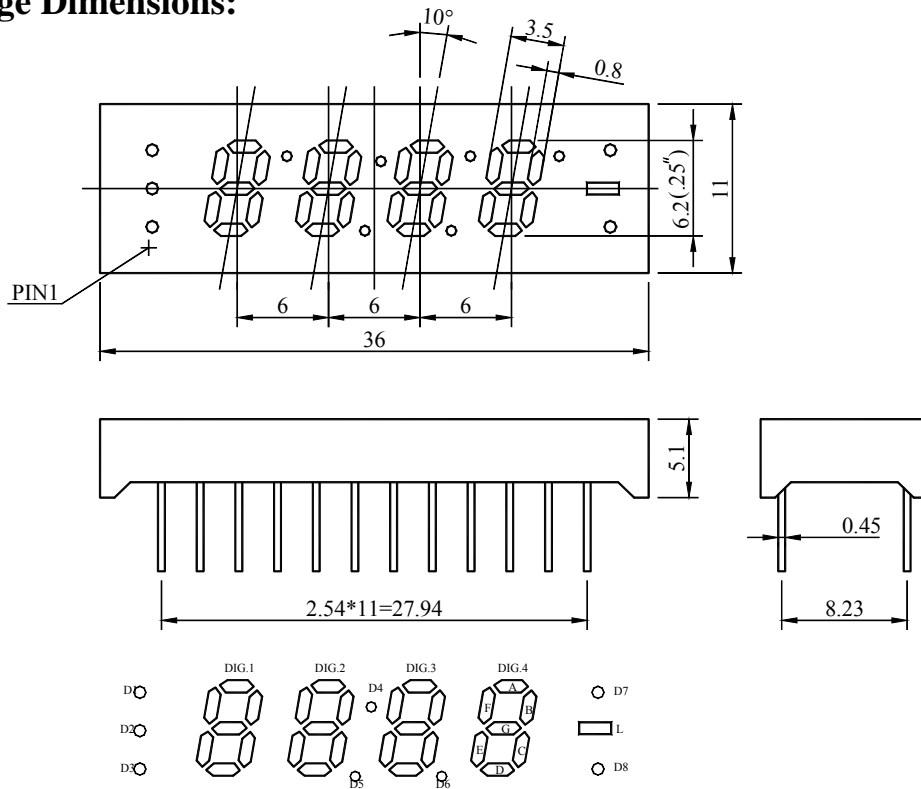

NOTES :

- All dimensions are in millimetres (mm), Tolerance is $\pm 0.25\text{mm}$ unless otherwise noted.
- Specifications are subject to change without notice.

Internal Circuit:

Common Cathode

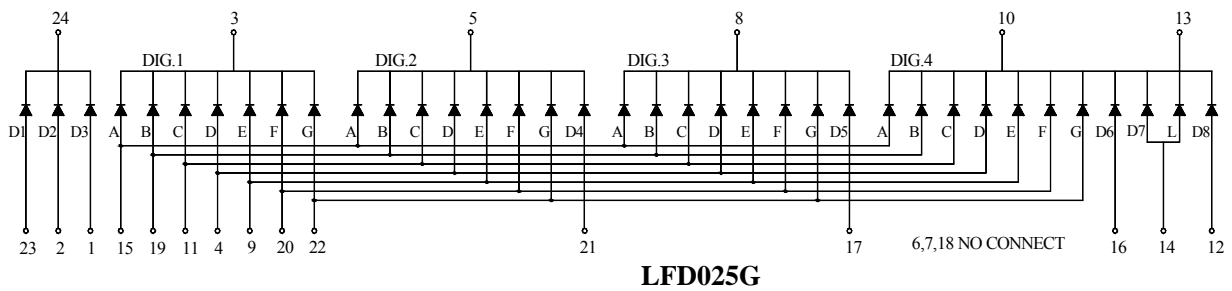

Common Anode

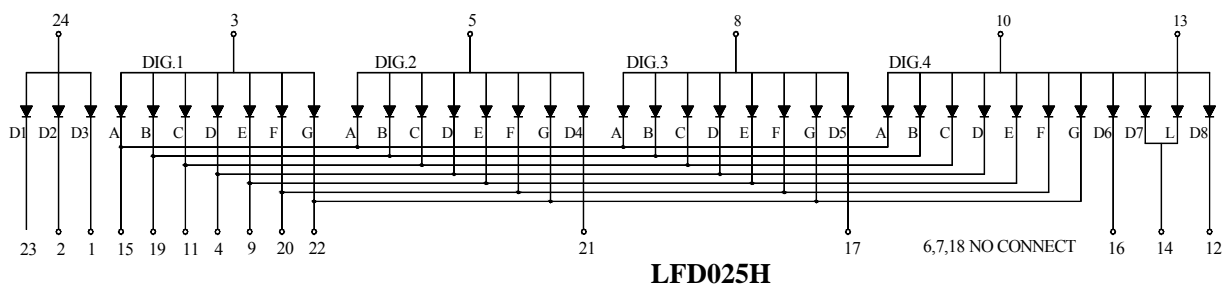

Reliability Test Items and Conditions

NO	Test Item	Test Conditions	Duration	Sample	Ac/Re
1	Temperature Cycle	-30 ~ 25 ~ 85 ~ 25 30min 5min 30min 5min	50cycles	100	0/1
2	High Temp. Storage	Ta=85	1000hours	100	0/1
3	Temp.& Humidity Test	Ta=85 RH=85%	1000hours	100	0/1
4	Low Temp. Storage	Ta=-30	1000hours	100	0/1
5	Operating Life Test	Ta=25 ± 5 DC IF=15mA	1000hours	100	0/1
6	Solder Heat	Tsol=260 ± 5 , 10s	1times	20	0/1

Typical Electro-Optical Characteristics Curves

